

access

L I G H T I N G

INSTALLATION INSTRUCTIONS

IMPORTANT

Before assembling your **ACCESS LIGHTING** fixture, please make sure that you carefully read through these instruction sheets. Consider having your fixture installed by a qualified licensed electrician.

NOTE: The important safeguards and instructions that appear in this manual are not meant to cover all possible conditions and situations that may occur. It must be understood that common sense, caution and care, are factors that can't be built into any product. These factors must be supplied by the person(s) caring for and operating the fixture.

GENERAL INFORMATION

All electrical connections must be in accordance with all ordinances, Local and National Electrical Codes. These fixtures are intended for mounting to a standard 4" x 2 1/2" metal octagon outlet box. The box must be directly supported by the building structure and U.L. Recognized.

STEP BY STEP INSTRUCTIONS

Before starting your installation disconnect the Power by turning off the Circuit Breaker or by removing the fuse at the fuse box. Just turning the light off at the light switch is not sufficient to prevent electrical shock.

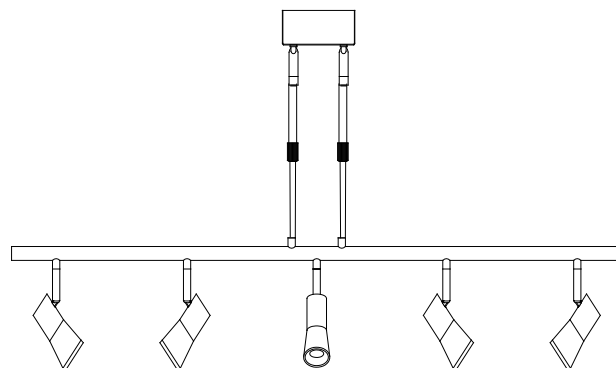

COLLECTION
SLEEK

APPLICATION
Pendant Fixture

MODEL NO.
63065LEDD

WHAT WE PROVIDE

- Crossbar
- Mounting Hardware
- LED

WHAT YOU NEED

- Screwdriver
- Wire Cutters
- Wiring Supplies as Specified by Electrical Code

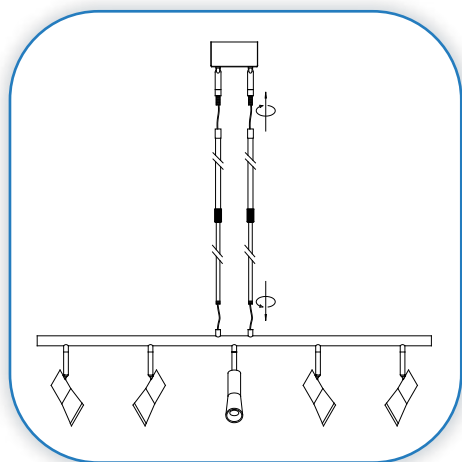

1

PREPARE FIXTURE

If there is an existing fixture remove it.
Expose the supply wires from the outlet box.
Tighten 2 sets of rods to the canopy and fixture.
Determine the desired length of your fixture; loosen the knurled thumb nuts, located on the rods of the fixture. Once the desired length has been determined tighten the knurled thumb nuts so that the rods remain secured.

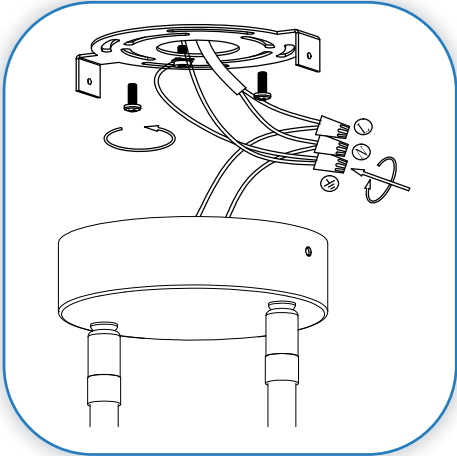

2

MAKE WIRE CONNECTIONS WITH DRIVER

Mount the crossbar to the J-box with the supplied screws. Gently pull the supply wires through the hole in the crossbar. Connect the black supply wire to the black driver input wire. Secure with the supplied wire nut. Connect the white supply wire to the white driver input wire. Secure with the supplied wire nut. Either wrap the green wire around one of the protruding screws or connect it to the supply ground wire. Secure all wires with electrical tape (not supplied). Tuck all wires carefully into the J-Box

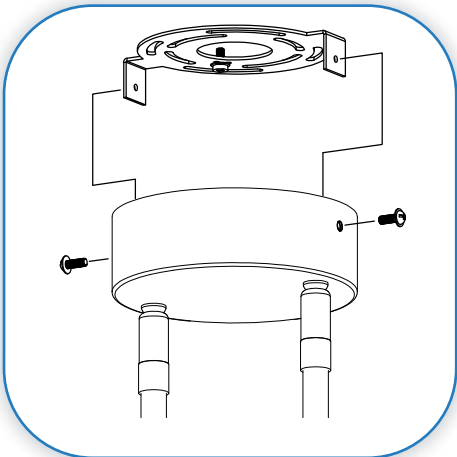

3

MOUNT THE CANOPY

Hold the canopy up to the crossbar. Align the holes at the side of the canopy and secure with the supplied screws.

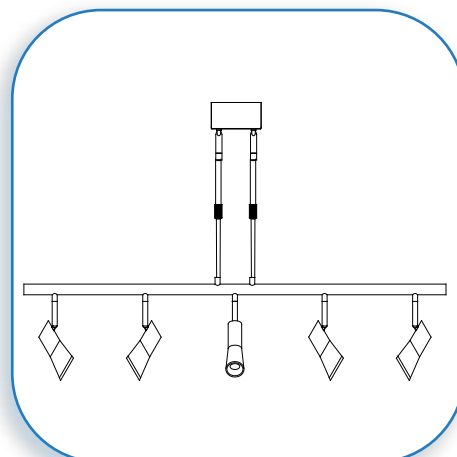

4

RESTORE THE ELECTRICITY AND CHECK THE OPERATION OF YOUR NEW ACCESS LIGHTING FIXTURE

CAUTION

If the fixture is to be removed or replaced, please ensure that the electricity is switched off and that the fitting is cool before touching it.